



# Entrance Systems Automatics - ESA



ENS (A)

dormakaba 

# Why Automatics?



Savings  
due to  
thermal  
management

Increased  
safety &  
security  
of building

Ease &  
convenience

Better  
aesthetics

Interface  
with building  
management  
systems

Secured  
door entry

Touch free  
hygienic  
door entry

Improved  
accessibility

Reduced  
noise  
and  
pollution

# Table of Contents



04

## Automatic Sliding Door Operators

- CS 80 Magneo
- CS 85
- ES 200 Easy
- ES 200 STD
- AL Series



08

## Automatic Sliding Door Profiles

- ST Flex
- ST G
- ST Flex Green
- ST Secure



11

## Complete Doors

- Telescopic Doors - TST
- Folding & Sliding Doors - FFT
- Breakout Doors - SST
- Breakout Doors - ESA 300
- Curved Sliding Doors - BST



17

## Automatic Swing Door Operators

- PORTEO
- ED 100
- ED 250
- ED 250 IG



21

## Revolving Doors

- KTV Atrium Flex
- KTV Flex Drive
- KTC 2
- KTC 3/4
- KTV Manual



27

## Special Door Solution

- Disabled Toilet Entrance
- Airlock door solution
- Alexamatics
- Hurricane door



31

## Accessories

# Automatic Sliding Door Operators



# CS 80 MAGNEO

## Internal Door Application



- The Slimmest automatic sliding door operator with a size of 60 x 62 mm has minimum visual interruption
- Smooth and noiseless operation due to electromagnetic drive technology
- This operator doesn't require additional safety sensors due to low energy drive
- Ideal for internal application on wooden door, glass door and metal doors

Parameter	CS 80 Magneo*
<b>Door panel weight in kg</b>	
Single Panel	1 x 80
Double Panel	Synchronised
<b>Clear passage width (LW) in mm</b>	
Single Panel	875 / 1000 / 1125
Double Panel	1750 / 2000 / 2250
<b>Standard operator length in mm</b>	1840 / 2090 2340
<b>Weight of the operator (max) in kg</b>	10.2
<b>Power supply</b>	220 - 230 V AC ±10% 50/60 Hz

\* Internal door application only

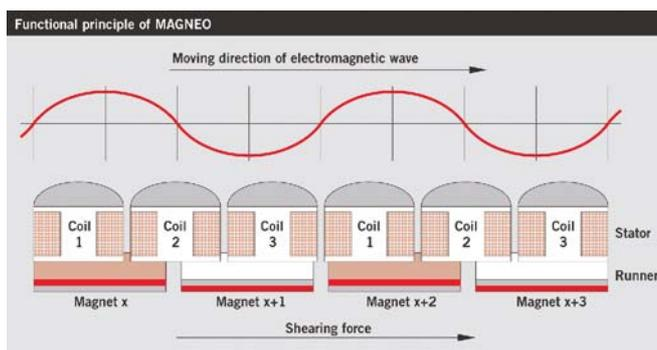

## CS 85

Light duty door operators



- CS 85 is the most compact operator with the profile size of 100 x 100 mm
- It is the basic range and value for money automatic sliding door operator
- CS 85 exhibits outstanding operational smoothness and efficiency
- Reliable function and high safety standards with Various modes : Off, Automatic, Permanent open, Exit only, Partial open,

## ES 200 STD / Easy

Medium duty door operators



- The Premium Range of ES 200 Series automatic sliding door operator fits into most of the entrance application with an operator size of 180 x 100
- The ES 200 STD system has functional - module which can do beyond automatics such as - Door Status contacts, Synchronised mode, Emergency closing, Airlock doors , Main and secondary edge protection
- ES 200 Series are tested for 1 Million Cycle of operation, Compliance with CE & DIN 18650 Safety Standards for Pedestrian Doors

Parameter	CS 85	ES 200 Easy	ES 200 STD
<b>Door panel weight in kg</b>			
Single Panel	1 x 100	1 x 120	1 x 200
Double Panel	2 x 85	2 x 100	2 x 160
<b>Clear passage width (LW) in mm</b>			
Single Panel	1000 - 1600	700 - 3000	700 - 3000
Double Panel	1000 - 2000	800 - 3000	800 - 3000
<b>Clear passage height (LH) in mm**</b>	2100 - 3000	2100 - 3200	2100 - 3200
<b>Standard operator length in mm</b>	4150	4150 6250	4150 6250



\*\* Other dimension on request

# AL Series - 401 / 501 / 1001

Heavy duty door operators



- The AL Series - Heavy Duty operators are engineered to smoothly operate and control very large door panel of weight even up to 1000 kg
- AL Series has 3 phase 24 VAC high torque motor, coupled with 12:1 gearbox ratio for powerful operation
- An optional rechargeable battery reserve to ensure the doors remain locked for up to 48 hours under main power failure
- The AL Series operator have an optional electric motor lock, by which doors can be locked anywhere in the travel position
- The Operator has high speed emergency close & locking option
- AL Series operators are proven performers in many large commercial applications such as, airport, industry, shopping center, supermarket, hotel, hospital, financial institution, sports stadium etc

Parameter	AL 401	AL 501	AL 1001
<b>Door panel weight in kg</b>			
Single Panel	1 x 400	1 x 500	1 x 1000
Double Panel	2 x 200	2 x 250	2 x 500
<b>Clear passage width (LW) in mm</b>			
Single Panel	1 x 3000	1 x 3000	1 x 3000
Double Panel	2 x 2000	2 x 2000	2 x 2000

# Automatic Sliding Door Profiles



## ST-FLEX Profiles



- ST-Flex profiles are safe, secure, flexible and reliable for a wide range of applications for convenience of pedestrian access solution
- Excellent insulation features, thanks to interlocking side seals and top and bottom seals
- ST-Flex Profile has high stability and torsional rigidity

## ST-G Profiles



- ST-G is the ideal solution for the sleek and slim profile thickness size as small as 16mm
- Excellent insulation features, thanks to interlocking side seals, top and bottom seals
- ST-G profile system provides visual openness and stability in various configuration



Parameter	ST-Flex	ST-G
<b>Max. Single Profile Width x Height</b>		
Single Panel (in mm)	1500 x 3000	1500 x 3000
Double Panel (in mm)	3000 x 3000	3000 x 3000
<b>Max. Weight Carrying Capacity (in kgs)</b>	200	160
<b>Glass Thickness (in mm)</b>	8 - 22	10
<b>Seal for Standard Glass Thickness (in mm)</b>	8/10/12/15/22	10
<b>Profile Size (in mm)</b>	30 x 47	15 x 46

## ST-Flex Green



- ST Flex Green Profile system provides thermal insulation in conjunction with excellent energy-saving by interlocking side seals and top and bottom seals
- Elegant fine-frame design, with high stability and rigidity
- Protection against draughts via circumferential seals
- Sustainable, reliable and energy-saving system



## ST-Flex Secure



- This system unites the convenience of an automatic door with an effective burglary and vandalism protection in compliance with burglar resistance class RC2
- Suitable for P4A security double glazing (22 mm LSG) and mono safety glazing (10 mm LSG)
- A continuous floor guide rail at the bottom of the door and an operator is integrated with anti-tamper protection avoid that the door is levered out by unauthorised entrants
- Four-point hook locking device with an automatic locking action at the main closing edge and lateral door profiles for the security

Parameter	ST- Flex Green	ST- Flex Secure
<b>Max. Single Profile Width x Height</b>		
Single Panel (in mm)	1500 x 3000	1500 x 3100
Double Panel (in mm)	3000 x 3000	3000 x 3100
<b>Max. Weight Carrying Capacity (in kgs)</b>	200	200
<b>Glass Thickness (in mm)</b>	8/10/12/15/22	LSG 10/22
<b>Profile Size (in mm)</b>	37 x 47	30 x 47

Burglar Resistance



RC2



# Complete Doors



## Telescopic Sliding Door - TST



- Telescopic mechanism creates 33% more wider passage in comparison to same size of Bi-parting Automatic sliding door
- Tested to 1 Million cycles, the ES 200 TST is a high quality, high performing modular automatic sliding door operator unit giving reliable performance
- Allows maximum opening width to be achieved in the given space thereby easing traffic flow
- Excellent installation features thanks to interlocking side seals, top and bottom seals

Door parameter	Clear passage width (LW) in mm	Clear passage height (LH) in mm	Max. weight of sliding panel in kg
Double Panel	800 - 2400	2100 - 3000	2 x 75
Four Panel	1400 - 4000	2100 - 3000	4 x 75



## Folding and Sliding Door - FFT



- FFT folding and sliding door occupies the minimum of the door opening width and extremely little in depth
- FFT makes it especially suitable for narrow door openings, passageways where space is limited and it is particularly suitable for emergency exits and escape routes
- Jam-free profiles and No floor track requirement for internal applications, enabling unbroken floor finishes
- The innovative operating system of FFT FLEX detects wind loads and compensates accordingly to guarantee a smooth opening and closing behavior.

Door parameter	Clear passage width (LW) in mm	Clear passage height (LH) in mm	Max. weight of sliding panel in kg
Single Panel	840 - 1240	2100 - 2500	1 x 90
Double Panel	980 - 2480	2100 - 2500	2 x 90



## Breakout Door - SST

EN / DIN compliance



- SST Breakout door profiles highly recommended in emergency exit and escape route doors with break-out panels and side screens
- The door panels and also the fixed panels are pivot-mounted to swing out when needed - without the need to disengage any locks
- 220 N force is applied against the door panels and side screens of automatic break-out sliding door systems suffices to activate the break-out function, leaving the way out free as per DIN 18650 and EN 16005
- This breakout opening can be utilised to turn the entrance area of shops and department stores to make additional sales space

Door parameter	Clear passage width (LW) in mm	Clear passage height (LH) in mm	Max. weight of sliding panel in kg
Double Panel	2100 - 2500	2100 - 2500	2 x 110

\*Single panel available on request

# Breakout Door - ESA 300

ANSI compliance



- dormakaba ESA 300 doors are commercial grade, high traffic volume automatic sliding doors designed to be the strongest in the Industry
- All ESA door packages are manufactured in the USA with a heavy-duty, German-engineered controller in compliance with ANSI standards
- ESA 300 doors are sturdy, reliable access in travel centres, retail outlets, office buildings, healthcare facilities, and countless other building types
- This Breakout features enhance to swing open the sliding and fixed panel with the force not exceeding 222N on the leading edge

Door parameter	Clear passage width (LW) in mm	Clear passage height (LH) in mm	Max. weight of sliding panel in kg
Double Panel	1100 - 1850	2100 - 3000	2 x 110

\*Single panel available on request

# Automatic Curved Sliding Door - BST



- BST automatic curved sliding doors are the perfect answer to providing entrance areas with a customised and aesthetically pleasing appearance.
- The doors can be designed as outwardly or inwardly curved, semi-circles and segments
- BST Automatic Circular door can perform draught exclusion and airlock functions

Clear passage width (LW) in mm	Clear passage height (LH) in mm	Max. Weight of Sliding panel in kg
1000 - 2500	2100 - 2500	1 x 130

Semi-circular design



Segmental design

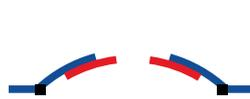

Two doors Semi-circular design

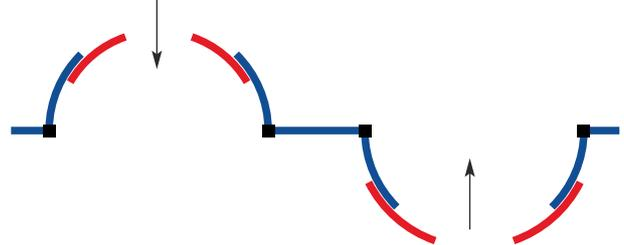

Circular design

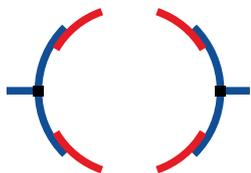

Combi Segmental design

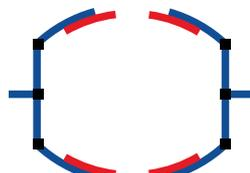

Combi Semi-circular design

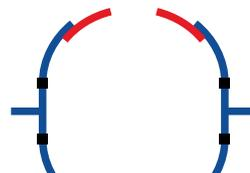

Three entrance Circular door

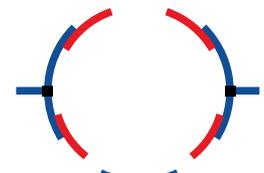

# Automatic Swing Door Operators



# PORTEO



- The low energy PORTEO automatic swing door is suitable for indoor application
- Compact dimensions of 60 x 530 x 80mm (HxWxD), particularly suitable for use in conjunction with narrow-stile and standard profile door systems
- Virtually noiseless operation and easy to install
- PORTEO has selective operating modes of power motion and permanent open



reddot design award  
winner



Door parameter	PORTEO
Maximum Door Leaf width in mm	1100
Maximum Door-leaf weight* in Kg	100
Duty	Light

\* Based on lintel depth dimension ( Available in catalogue)

## ED 100 / ED 250



- ED 100 / ED 250 Automatic swing door is the perfect solution for both internal and external applications
- Optional integrated door co-ordinator to ensure the correct closing of rebated double doors
- Suitable for an emergency escape, fire doors and reliable performance even in cold environments upto -15°C
- The Wind Load Control function is ideal for windy sites compensating for wind loads tested upto 61 kmph for door size of 990 x 2250mm
- Flip - Flop Function, Full Energy Speed control, nurse bed function options available via upgrade cards
- Integrated Program Switch has OFF / Automatic / Permanent Open / Exit only functions



Door parameter	ED 100	ED 250
Maximum Door Leaf width in mm	1100	1600
Maximum Door-leaf weight* in Kg	160	400
Duty	Medium	Heavy

\* Based on lintel depth dimension ( Available in catalogue)



## ED 250 IG

Low energy in-ground auto swing door operator

NEW

- The powerful ED 250 IG in-ground auto swing door operator is the perfect solution for operating heavy doors as concealed auto swing door closer
- Pit size of 920 x 195 x 140mm can accommodate the operator, with the ability to support doors weighing up to 270kg.
- The perfect applications were the clean lines of an all-glass façade need to be preserved or the design integrity of a historical building needs to be maintained.
- It can be installed in both new construction and retrofit applications. Available for single or paired applications, the operator integrates with any access control system.

Parameter	ED 250 IG
Maximum Door Leaf width in mm	1200
Maximum Door-leaf weight* in Kg	270
Duty	Heavy

\* Based on lintel depth dimension ( Available in catalogue)



# Revolving Doors



# KTV Atrium Flex

NEW



- KTV Atrium is the World's first Ceiling mounted flex drive system in Glass Canopy Revolving door
- No more underground drive system, thus by avoiding water and dust ingress into the drive system
- Unique individualised look with illuminated accent in the ceiling mounted flex drive
- The gearless power transmission is based on MAGLEV technology with electromagnetic direct-drive principle, minimizes the tolerances and wear with quiet noiseless operation

Internal Diameter (in mm)	Clear Passage Height* (in mm)	Canopy Height (in mm)	No. of Leaves	Standard Finish
2000 - 3000	2100 - 3000	28	3 / 4	SS Cladding

\* Please refer diameter Vs Height Dependency Chart for correct combination

Tested for  
2 million  
cycles

# KTV Flex



- Aesthetically designed World's first slimmest drive with just 100mm height canopy
- Engineering enabled breakthrough in design with noiseless drive through MAGLEV technology
- MAGLEV technology allows for compact quiet drive designs without wear and tear parts. The door wings can be moved and positioned very accurately.
- 2 Million Cycle tests certified on the Flex drive compared to 1 Million cycle of conventional gear drive for long lasting operation

Internal Diameter (in mm)	Clear Passage Height* (in mm)	Canopy Height (in mm)	No. of Leaves	Standard Finish
2000 - 3800	2100 - 4000	100	3 / 4	Anodized / RAL

\* Please refer diameter Vs Height Dependency Chart for correct combination



## KTC 2



- KTC 2 Revolving doors creates a massive entrance to a building that is ideal for use in high traffic areas such as hotels, offices, shopping centres and airports
- The Intelligent KTC 2 Revolving door has an integrated automatic sliding door in the revolving turnstile system
- KTC 2 works in dual ways such as revolving door system for average traffic capacities and sliding door for heavy user traffic or bulky items to be carried

Internal Diameter (in mm)	Clear Passage Height* (in mm)	Canopy Height (in mm)	No. of Leaves	Standard Finish
KTC 2 3600 - 5400	2100 - 3000	300 - 700	2	Anodized / RAL

\* Please refer diameter Vs Height Dependency Chart for correct combination



# KTC 3/4



- KTC 3/4 Revolving doors create a massive entrance to a building that is ideal for use in high traffic areas such as hotels, offices, shopping centres and airports
- The high traffic volumes are handled by these doors without any difficulty. In addition, the optional pivot-mounted wings will fold out (book fold mechanism) in any position to provide a clear escape route
- The KTC 3/4 Central Turnstile versions has an option to go with an attractive display showcase version in which customers / Architects can display their products as showpiece

Internal Diameter (in mm)	Clear Passage Height* (in mm)	Canopy Height (in mm)	No. of Leaves	Standard Finish
KTC 3 3600 - 6000	2200 - 2500	420 - 700	3	Anodized / RAL
KTC 4 3600 - 6200	2200 - 2500	420 - 700	4	Anodized / RAL

\* Please refer diameter Vs Height Dependency Chart for correct combination



# KTV Manual



- Cost effective solution for the customer who steps into the revolving door concept
- It controls the flow of inward and outward traffic movement
- Effective noise, dust & dirt protection
- Optimisation of the building energy management

<b>Internal Diameter</b> (in mm)	<b>Clear Passage Height</b> (in mm)	<b>Canopy Height</b> (in mm)	<b>No. of Leaves</b>	<b>Standard Finish</b>
2000 - 2600	2100 - 3000	100	3/4	Silver anodised / RAL

# Special Door Solution



## Disabled Toilet Entrance Auto Door Assist

The Privacy door kit system the ideal automated door solution for disabled toilets, Parents room and baby change facilities.

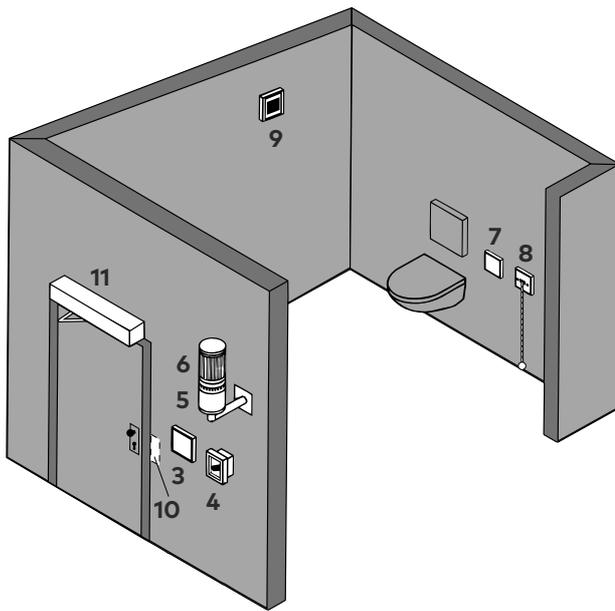

### Basic Kit

- Outside
  - 3 – Push Button
  - 10 – Electric Strike Plate / Electro Magnet
  - 11 – Operator along with safety Sensor (Swing / Sliding)
  - 5 – Occupied Lamp indicator
- Inside
  - 7 – Push button
  - 9 – Occupied Lamp indicator

### Add On - Emergency Kit

- Inside
  - 8 – Emergency Switch
- Outside
  - 6 – Audible emergency Siren
  - 4 – Emergency Break open Switch

- The Handicap Privacy Door System is the ideal Automated Toilet door Solution for disabled, elderly and Hospital applications
- The Handicap Privacy Door System can be fitted to either automatic swing or sliding door operators depending on the required design applications
- Easy to use and Flexible interface with Automatic Sliding & Swing Door Operators
- Optional Staff override function is available in case emergency support required by the user

### Products Used:

- Sliding Door: CS 80 / CS 85 with Light barrier
- Swing Door : ED 100 with IRS Safety Sensor
- Lock, Basic Kit, Optional Add-on Kit, Battery / UPS

## Airlock Module

Sliding door operator with Air-lock / Vestibule Function



- Airlock / Vestibule System helps to reduce the air-contact between two or multiple auto sliding / swing door partitions.
- When the first auto-sliding door is Closed then the Vestibule module will give signal to the next sliding door for opening. This ensures the limited air-contact between sliding door Partitions.
- Application includes - Healthcare Industry, Food Industry, Pharma Industry and Store fronts.

### Products Used:

- ES 200 Easy with External Vestibule Module
- ES 200 STD with functional Module
- ED 100 / 250 with integrated Vestibule Module
- Eagle 5+ Uni directional Radar

# Alexamatics

## MAGNEO with Alexa Partition



NEW



- Providing smart automatic entrance in Alexa demountable partitions by Integrating CS 80 MAGNEO auto sliding door system with push to slide function
- The MAGNEO is glass mounted on Alexa Partitions with a support of manets
- The door can be opened via – push button / Remote Control / Number key pad / Slide to open
- The Various door opening size are 875 / 1000 / 1125mm
- Smooth and noiseless operation, thanks to Magnetic Levitation Technology used in MAGNEO

### Products Used:

- Alexa Demountable Partitions
- CS 80 MAGNEO for opening size of (875 / 1000 / 1125mm) with integrated lock
- Glass mounting back plate with manets
- Wireless Push button / Remote control for opening

## ESA 300 HP

Hurricane resistant automatic sliding door



- dormakaba ESA 300 HP ( Hurricane Resistance) doors are durable, attractive design with clean lines, which decreases the cost of additional special hurricane shutters for windy locations
- Impact rated sliding automatic entrance systems shall be designed to withstand up to 2.63 kPa wind force in both the positive and negative direction
- The automatic sliding door accommodates 100 kg weight per panel on single or bi-parting door leaves

Door parameter	Clear passage width (LW) in mm	Clear passage height (LH) in mm	Max. weight of sliding panel in kg
Double Panel	1100 - 2000	2100 - 2400	2 x 110

\*Single panel available on request

# Accessories

Automatic door systems from dormakaba are designed to be safe for people to use. The movement range of the door panels/leaves is monitored by appropriate safety sensors during both the opening and closing cycles. The radar motion detector activates the door opening cycle. The light curtain or Safety Sensor delays the closing cycle as long as someone is located in the access area.

## Door Activators

### Eagle 5+

Uni - Directional Motion Sensor



- Eagle series were the most economical all-round solution for opening of all types of automatic sliding door with direction sensitivity.
- Eagle 5+ fitted with Motion Tracking features allows to open the door while the movement towards the door and Eagle 6+ detects all movements.

### Eagle 6+

Bi - Directional Motion Sensor



### Eagle HM

High Mounting Sensor



- The Eagle HM is the most competitive sensor to open all automatic doors for the sensor mounting height upto 5m

### IXIO - DT

Motion + Safety Sensor



- IXIO - DT Ranges are dual technology sensors combining the radar technology for the opening and active infrared technology for the safety in accordance with the EN 16005 standard
- IXIO Range uses unidirectional sensor that shows, the safety field in 48 high-density infrared spotlights from 2 level curtains

### IXIO - DT1V

Sensor with inbuilt Camera



- The IXIO - DT1V sensor includes an NTSC-compliant video surveillance camera that provides high quality footage of those entering and exiting a building besides sensing motion and inbuilt infrared for safety
- Has an SDTV camera that shoots 30 frames of footage per second and it can be Integrated with building surveillance systems

### VIO - DT

Motion + Safety Sensor



### VIO - M

Motion Sensor



- The VIO - DT combines a motion radar sensor for opening the door with a double failsafe active infrared curtain for the protection of users, in accordance with the EN 16005 standard
- Opening and closing of the door is controlled by an unidirectional radar and safety is ensured by the two 24-infrared spot failsafe curtains

### Zensafe

Motion + Safety Sensor



- Zensafe is the dual technology sensor combining the microwave technology for the opening and active infrared technology for the safety.
- Bi-directional sensing detection offering One set of safety curtain with 24 active infrared spots.

### Wireless Push Switch

Wireless Signal



- Wireless Push button can be pasted anywhere near to the automatic sliding door for activation
- Once the push button is pressed – it transmits radio signal to the receiver kept inside the operator module for activation of the door for Opening / Closing

### Card reader

Secured Access



- Card reader can fit on any standard flush-mounted wall box or Can be surface mounted (on-wall wiring) or flush mounted into the wall (in-wall wiring)

### BRC - Remote System

Authorised Access



- The BRC System operates with a bi-directional BidCoS wireless protocol
- The shock proof hand-held transmitter BRC-H is battery operated with 4 Channels. It has LED for feedback purposes, key stroke is enough to trigger an opening pulse in a reliable way with field range of 100 meter

### Magic Switch

Touch free Opening



- The Magic switch is based on contactless microwave sensor for activation of the door
- This is primarily used for hygiene applications such as hospital environments, hotels, restaurants, and pharmaceutical industries

### Push Button

Press to Open or Close



- It is Palm activated pushbutton with Stainless steel finish. The buttons are IP44 weather rated

# Safety Sensors

## IRS for Swing door

Infrared - Swing door safety sensor



- Infrared safety sensors are designed to detect all static and moving obstructions, either people or objects, within their detection range
- The sensor will institute the door to reverse and open, as soon as an obstruction is detected during a closing cycle. Infrared safety sensors are available in different lengths – 300 / 700 / 900 / 1200 mm and may be supplied in the same colour as the operator

## IXIO - S

Safety Sensor



- IXIO-S is an active infrared presence sensor used for safety of the passage areas in the main closing edge and secondary closing edge.
- 4 infrared spotlights visible on the ground to enable easy adjustment of the failsafe curtain. The IXIO - S can be mounted up to 3.5 m

## VIO - S

Safety Sensor



- The VIO-S is a presence sensor made up of a double failsafe active infrared curtain, offering high protection of individuals, thanks to the two 24-infrared spot failsafe curtains. The VIO - S can be mounted up to 3 m

## FLATSCAN

Laser - Swing door safety sensor



- FLATSCAN Sensor uses laser technology for safety of swing doors.
- One Sensor is enough to cover both the complete width and height on one side of swing door including the pinch zone. Two designs available for installation on the left or right opening of swing door

## Photo Cell

Infrared Sensor



- The small-sized infrared beams, composed by an emitter and a receiver in cylindrical heads, can be discreetly fitted into the profiles of single or double doors

Activators	Max. Mounting Height (in meter)	Wide Detection Range Wide x Depth (in meter)	Narrow Detection Range Wide x Depth (in meter)	Direction Sense	Infrared Safety in-built
Eagle 5+	3	4 x 2	2 x 2.5	Uni-Direction	No
Eagle 6+	3	4 x 2	2 x 2.5	Bi-Direction	No
Eagle HM	5	4 x 2.5	2 x 3	Bi-Direction	No
Zen Safe	3	4 x 2	2 x 2.5	Bi-Direction	Yes
IXIO - DT	3.5	4 x 2	2 x 2.5	Uni-Direction	Yes
IXIO - DT1V	3.5	4 x 2	2 x 2.5	Uni-Direction	Yes
VIO - DT	3	4 x 2	2 x 2.5	Uni-Direction	Yes
VIO - M	3	4 x 2	2 x 2.5	Uni-Direction	No





# Products & Solutions

## Access Solutions



Door Hardware  
- DHW

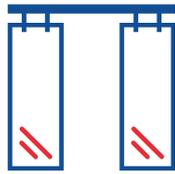

Interior Glass Systems  
- IGS



Entrance Systems  
- ENS

## Wall Solutions

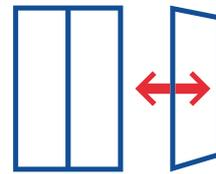

Movable Walls  
- MW



Mechanical Key  
Systems - MKS



Lodging Systems  
- LGS

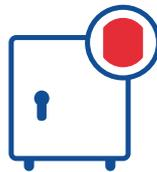

Safe Locks  
- SAL



Electronic Access &  
Data - EAD



Service  
- SVC

dormakaba India Private Limited  
Plot No. 48/3, Mahindra World City  
8th Avenue, Anjur Village  
Chengalpattu Taluk  
Kancheepuram District  
Tamil Nadu 603 002. INDIA  
T +91 44 67 400 200  
[enquiry.india@dormakaba.com](mailto:enquiry.india@dormakaba.com)  
[www.dormakaba.com/in-en](http://www.dormakaba.com/in-en)

**SERVICE TOLL FREE**

1800 121 6414